



SX Linear Strip Lights 5PC

2,3,4,6,8 feet



DESCRIPTION

The **SX** series is an LED linear bracket light that offers direct lighting. The lower light-emitting module features a PC tube cover, which provides a broader beam angle and higher light efficiency to better meet customer requirements. Easy installation, high light efficiency, and low cost can reduce usage expenses and enhance the overall space effect. The bracket is made from extruded color steel, lightweight and superior quality. The direct and lampshades are made of fire-resistant PC material that meets UL94-V2 safety standards. The lights are available in three lengths of 2 feet, 3 feet, 4 feet, 6 feet and 8 feet and can be connected continuously.

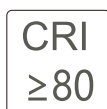

SELLING POINT

1. Easy and lightweight to connect;
2. The light source module uses a regular PC tube cover, with a broad beam angle and softer light;
3. The lower light-emitting module uses a tubular milky white PC cover;
4. Adjustable power and CCT via dip switch;
5. Compatible with emergency and 0-10V dimming solutions;
6. Available in suspension, ceiling, or splicing installation;
7. Operating voltage options include AC120-277V and AC120-347V;
8. 5-year warranty;
9. Can be used as emergency function, 1.5H emergency time, 8w emergency power.

APPLICATION

- Office
- Exhibition Hall
- Hotel
- Entertainment venue
- Schools
- Supermarkets
- Hospitals
- Warehouses

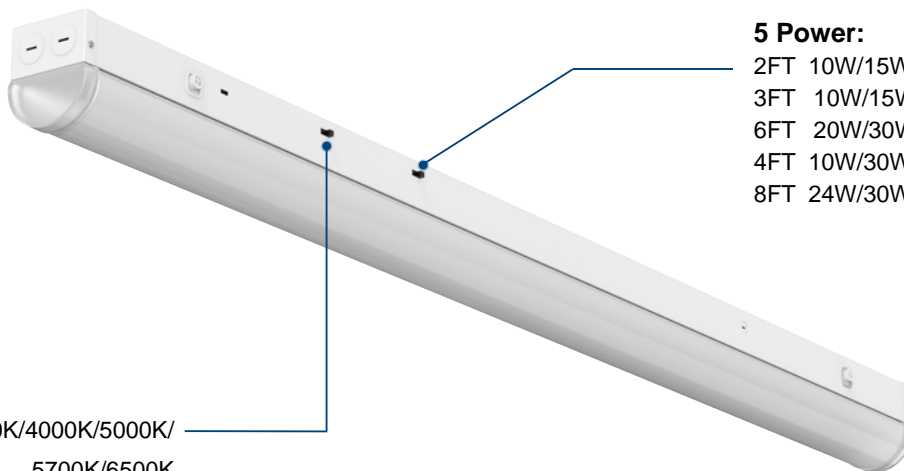

5 Power:

- 2FT 10W/15W/17.5W/20W/25W
- 3FT 10W/15W/20W/25W/30W
- 6FT 20W/30W/40W/50W/60W
- 4FT 10W/30W/35W/40W/50W
- 8FT 24W/30W/50W/64W/80W

5 CCT: 3500K/4000K/5000K/
5700K/6500K



DIFFERENT LUMINOUS EFFECT DISPLAY

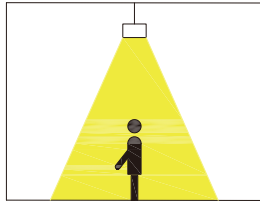

Pendant (Down)

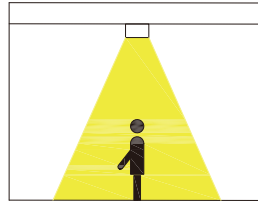

Surface mounted

PRODUCT INFORMATION

Model	LLSL-SX225-5PC-D1	LLSL-SX330-5PC-D1	LLSL-SX440-5PC-D1	LLSL-SX660-5PC-D1	LLSL-SX880-5PC-D1
Size	2FT	3FT	4FT	6FT	8FT
Power	10W/15W/17.5W /20W/25W	10W/15W/20W/ 25W/30W	12W/20W/30W /35W/40W	20W/30W/40W/ 50W/60W	24W/30W/50W/ 64W/80W
CCT	3500K/4000K/5000K/ 5700K/6500K	3500K/4000K/5000K/ 5700K/6500K	3500K/4000K/5000K/ 5700K/6500K	3500K/4000K/5000K/ 5700K/6500K	3500K/4000K/5000K/ 5700K/6500K
Light effect	130LM/W	130LM/W	130LM/W	130LM/W	130LM/W
Lumen	1300LM/1950LM/2275LM /2600LM/3250LM	1300LM/1950LM/2600LM/ 3250LM/3900LM	1560LM/2600LM/3900LM /4550LM/5200	2600LM/3900LM/ 5200LM/6500LM/7800LM	3120LM/3900LM/6500LM /8320LM/10400LM
Voltage	120-277Vac/120-347Vac				
Beam angle	120°				
CRI	80≥				
Glare value	UGR<22				
drive	Novbo/CUPOWER				
Dimming method	0-10V				
Sensor	/				
Emergency	/	8W/1.5H	/	8W/1.5H	
Electrical rating	Class I				
Protection level	IP20				
Anti-collision grade	IK05				
Fire-proof level	94-V2				
Optical materials	PC				
Main material	Fe&PC				
Lifespan	5 years				
Working temperature	-20℃~50℃				
Storage ambient	-20℃~60℃				
Installation	Suspension, ceiling, or splicing installation				

DIMENSION DRAWING (UNIT: MM/INCH)

lengths	A	B	C
2FT	604(23.78")	75(2.95")	83(3.26")
3FT	906(35.67")	75(2.95")	83(3.26")
4FT	1220(48.03")	75(2.95")	83(3.26")
6FT	1812(71.34")	75(2.95")	83(3.26")
8FT	2438(95.98")	75(2.95")	83(3.26")

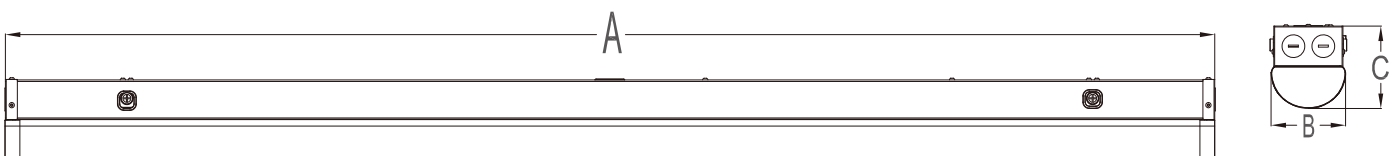

CONTINUOUS ROW MOUNTING

5G LED Strip Light Linkable QTY

Size	Watts	100-277V		100-347V		Suggested Linkable QTY
		Current	QTY	Current	QTY	
2FT	10/15/17.5 /20/25	0.23	24	0.1	55	≤24 PCS
3FT	10/15/20 /25/30	0.35	19	0.15	40	≤19 PCS
4FT	12/20/30 /35/40	0.46	15	0.2	34	≤15 PCS
6FT	20/30/40 /50/60	0.63	10	0.27	22	≤10 PCS
8FT	24/30/50 /64/80	0.83	7	0.36	17	< 7 PCS

5G LED Strip Light Linkable QTY

Size	Watts	100-277V		100-347V		Suggested Linkable QTY
		Current	QTY	Current	QTY	
2FT	10/15/17.5 /20/25	0.23	24	0.08	69	≤24 PCS
3FT	10/15/17.5 /20/25	0.35	19	0.13	55	≤19 PCS
4FT	12/20/30 /35/40	0.46	15	0.16	43	≤19 PCS
6FT	20/30/40 /50/60	0.63	10	0.22	27	≤10 PCS
8FT	24/30/50 /64/80	0.83	7	0.29	21	<7 PCS

MOUNTING / ACCESSORIES

included



Ceiling (2FT/3FT/4FT)

included



Ceiling (6FT/8FT)

LLSL-SX-SSP

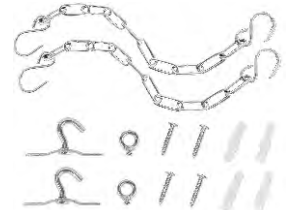

Suspending installation

LLSL-SX-BB same SK



Ceiling splicing (2FT/3FT/4FT)

LLSL-SX-BB

Binding Bracket



Ceiling splicing (6FT/8FT)

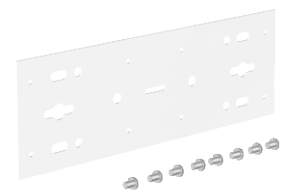

Suspension splicing

included



Hook

LLSL-SX-SS same SK



Microwave induction

LMDP-HPB8



Emergency power supply

REMOTE HANDSET HD05R SAME SK

LLSL-SX-RH

PACKAGING INFORMATION

Model	Size	Product Size	Net weight	Outer box gross weight	Carton size	Packing Qty.	Carton gross weight
LLSL-SX225-5PC-D1	2FT	604*75*83mm	0.83Kg	1.2Kg	630*350*200mm	8	7.84Kg
LLSL-SX330-5PC-D1	3FT	909*75*83mm	1.2Kg	1.4Kg	933*350*200mm	8	10.8Kg
LLSL-SX440-5PC-D1	4FT	1218*75*83mm	1.5Kg	1.9Kg	1245*350*200mm	8	13.9Kg
LLSL-SX660-5PC-D1	6FT	1821*75*83mm	2.0Kg	2.2Kg	1845*350*200mm	8	18.2Kg
LLSL-SX880-5PC-D1	8FT	2439*75*83mm	3.12Kg	2.34Kg	2465*350*200mm	4	14.82Kg



NOTICE

- Please read the specification first, to make sure the service environment matches the condition in the specification before using.
- Please confirm the applicable power supply before using.
- Make sure the switch of product is off before connect to the power supply to prevent electric shock.
- Operation against rules may damage your property even harm to your personal safety.
- Preliminarily estimate required quantity of LED panel lights, then according to the power rating of single panel light to figure out the total power and design power supply plan.
- Dangerous high voltage, Non-professionals are not allowed to maintain the products.
- If the exterior flexible cable or wire is damaged, it must exchange by the supplier, its agent or other similar qualified personnels to avoid dangers.